

CB-8



CB-6

DELTRAN

The Genuine Wrap Spring™

CB Series – sizes 2, 4, 5, 6, 7, 8, 10

Super CB Series – sizes 5, 6, 7, 8, 10

SAC Series – sizes 2, 4, 5, 6

Installation and Mounting Manual

06/2008

Keep all product manuals as a product component during the life span of the product.

Pass all product manuals to future users/owners of the product.

Record of Revisions

Edition	Valid for	Description
06/16/08	CB Series, Super CB Series and SAC Series	New installation and mounting manual

Trademarks:

The Genuine Wrap Spring™

Technical changes to improve the performance of the equipment may be made without notice !

Printed in USA.

All rights reserved. No part of this work may be reproduced in any form (by printing, photocopying, microfilm or any other method) or processed, copied or distributed by electronic means without the written permission of Thomson.

- 1. Pre-Installation Inspection4**
- 2. Mounting and Installation4**
 - 2.1. Warning!..... 4
 - 2.2. Backing Plate Assembly..... 4
 - 2.3. Input/Output Rotation 4
 - 2.4. Shaft Support Connection 4
 - 2.5. Belt, Chain or Gear Drive Connection 4
- 3. Mounting Requirements5**
 - 3.1. Horizontal and Vertical Mounting 5
 - 3.2. Preferred Horizontal Mounting 5
 - 3.3. Optional Vertical Mounting 5
 - 3.4. Optional Mounting Configurations 6
- 4. Mounting Thread Engagement7**
 - 4.1. Thread Engagement Requirements 7
- 5. Stop Collar Output Adjustment8**
 - 5.1. Stop Collar Adjustment and Removal 8
 - 5.2. Stop Collar Positioning Increments 8
- 6. Performance9**

Deltran Genuine Wrap Spring clutches and clutch/brakes are factory assembled, requiring no adjustments during installation. To adjust the output positioning of the unit, see "Stop Collar Output Adjustment" on page 8 (5.1).

⚠ WARNING Failure to follow these instructions may result in product damage, equipment damage, and serious or fatal injury to personnel.

1. Pre-Installation Inspection

- 1.1. Examine the unit for any damage, which may have occurred during shipping. Check the unit to ensure it meets your application's requirements, such as shaft fit and coil voltage. In addition, make sure all parts are clean and free of any foreign material prior to assembly.

2. Mounting and Installation

- 2.1. **⚠ WARNING** Whenever attempting to install this type of product used for engaging and stopping components on a machine, it is strongly recommended that the machine be put in a safe condition prior to servicing.
- 2.2. **Backing Plate Assembly** - Each clutch/brake backing plate assembly has three or four mounting holes plus an anti-rotation slot, and is designed to serve as a torque arm rather than as a rigid mounting plate. The plate should be restrained from rotating by a pin or shoulder bolt, while allowing it to float axially. The anti-rotation device must be capable of withstanding the braking torque required by the load.

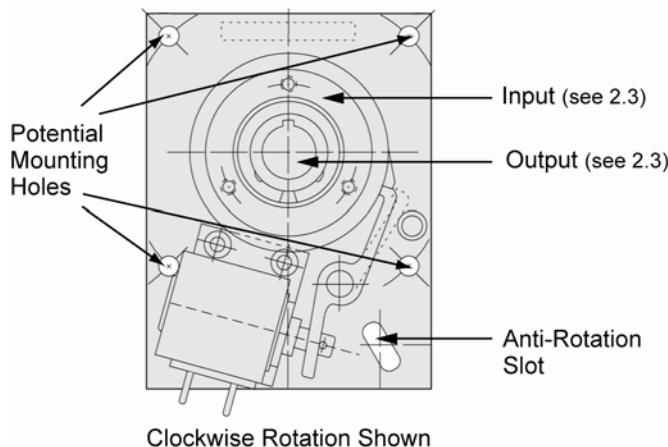

Important: Do not rigidly mount unit. Plate must be allowed to "float" axially.

- 2.3. **Input/Output Rotation** - On CB type units, the input rotation is always connected to the input hub, and the output is always through the hollow bore of the clutch/brake shaft.
- 2.4. **Shaft Support Connection** - All Deltran wrap spring products are designed to be installed in parallel shaft applications where they are fully supported by the shaft on which they are mounted. Connecting the unit to the parallel shaft may be accomplished by pinning (for sizes 2, 4 and 5) or by key and set screw (for sizes 6, 7, 8 and 10).
- 2.5. **Belt, Chain or Gear Drive Connection** - When connecting the parallel shaft to the CB by using a belt, chain or gear drive, the input hub's radial bearing load capacity must not be exceeded. It may be necessary to counter bore or bearing mount the input pulley sprocket or gear. (See "Mounting Thread Engagement" on page 7 for additional information).

3. Mounting Requirements for Super CB, Standard CB and SAC Units

(All plated mounted wrap spring products)

- 3.1. **Horizontal and Vertical Mounting** –The Genuine Wrap Spring clutches are self-contained packaged products which are easy to mount. A few simple precautions should be taken to ensure maximum life. All Genuine Wrap Spring clutch products are designed for parallel shaft applications where they are fully supported by the shaft on which they are mounted. In the case of CB wrap spring clutch/brakes, the through shaft is always the output. Connecting the parallel shaft to the CB input can be accomplished by use of a belt, chain or gear drive. CB models must be mounted with the shaft(s) in a horizontal position (Figure 1). If vertical mounting is required, see Figure 2.

Preferred Horizontal Mounting

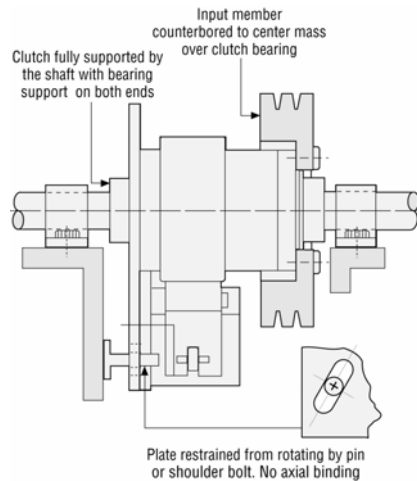

Figure 1

Optional Vertical Mounting

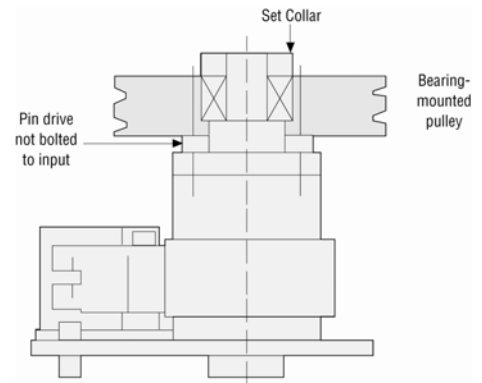

Figure 2

- 3.2. **Preferred Horizontal Mounting** - Figure 1 shows an ideal CB mounting. The unit is locked to the output shaft with a key and set screws. The mounting plate is restrained from rotating with a pin, but is not restrained axially, reducing the load on the CB's internal plate bearing. The anti-rotation device employed must be able to withstand the braking torque required by the load. It may be desirable to have easy access to the input for changing belts, etc. In this case, the clutch/brake can be mounted on a stub shaft. If so, the unit must still be fully supported. Overhung loads on the input member must be avoided to secure long radial bearing life.
- 3.3. **Optional Vertical Mounting** - Figure 2 - When applying a wrap spring vertically, the mating drive member (pulley, sprocket, or sheave) must be bearing-supported as shown in Figure 2. This is necessary to eliminate the axial loading that will occur from the weight of the mating drive member (pulley, sprocket or sheave).

Preferred Pulley Mounting

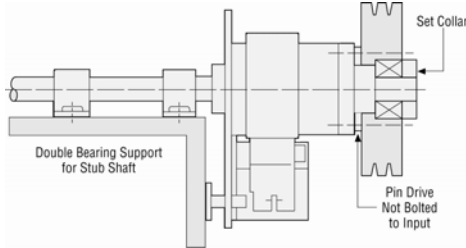

Figure 3

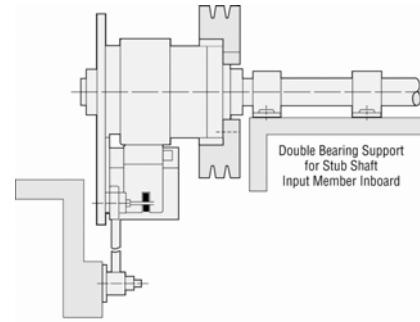

Figure 4

- 3.4. **Optional Mounting Configurations** – Figures 3 and 4 illustrate how proper support can be provided. Input members are generally face-mounted to the input hub of the unit as shown on Figure 1. This is facilitated by drilled and tapped holes provided in the free hub flange. The set-up shown in Figure 3 is possible if the radial load to the input hub of the clutch is small compared to the specified load. With a substantial load, arrange the pulley over the centerline of clutch free hub as shown in Figure 4. The solution presented here is better than that in Figure 3. Place one support bearing as close to the pulley as possible. Use a torque arm for anti-rotation. Small units (size 2, 4, and 5) are provided with pilot holes in the output shaft. These guide drilling through the machine shaft for attachment of the unit, accomplished by a pin.

4. Mounting Thread Engagement

4.1. **Thread Engagement Requirements** – While mounting a sprocket or pulley to the input hub of your Standard/Super CB-2, 4, 5, 6, 7, 8, 10 or SAC-2, 4, 5, or 6 the screws/bolts used must not protrude through the flange or hub. This will interfere or jam the control collar assembly, causing the clutch to malfunction by failing to "drive" or causing the clutch to "slip". Please refer to the following chart for maximum thread engagement.

CB Std./SAC-2	= .150
CB Std./SAC-4	= .280
CB Std./Super CB/SAC-5	= .350
CB Std./Super CB/SAC-6	= .312
CB Std./Super CB-7	= .280
CB Std./Super CB-8	= .360
CB Std./Super CB-10	= .500

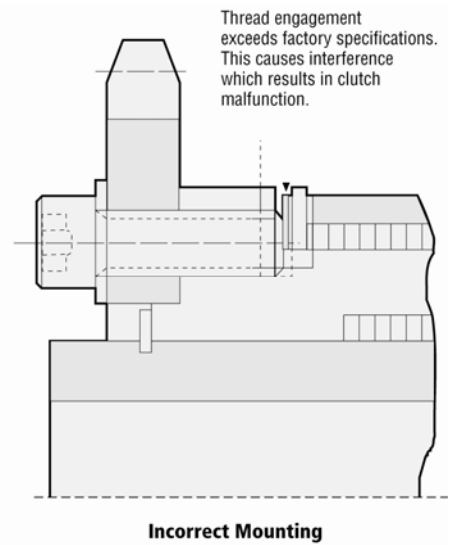
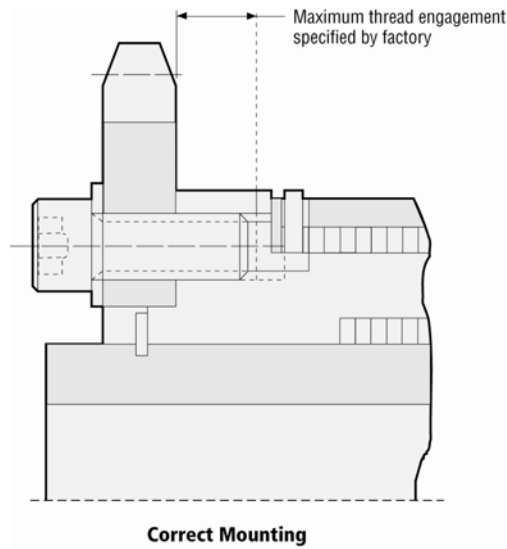

5. Stop Collar Output Adjustment

5.1. **Stop Collar Adjustment & Removal** - Unique splined stop collars are a standard feature of Super and Standard CB, as well as the PSI and SAC model clutches. These stop collars can be adjusted radially in fine increments. This feature allows the user to reposition the output to comply with specified shaft and keyway placements. Standard stop collar positioning increments are shown in the table below.

Split Cam Design

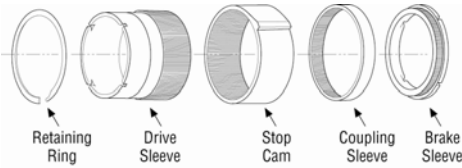

The Split Cam stop collar design is a standard feature on Super CB Sizes 5, 6, 7, 8; Standard CB Sizes 5, 6, 7, 8 and SAC Sizes 5, 6.

Traditional Cam Design

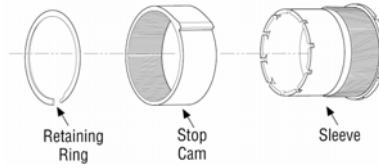

The Cam stop collar design is a standard feature on Super CB Size 10; Standard CB Sizes 2, 4, 10 and SAC Sizes 2 and 4.

Collar Removal and Adjustment – To adjust the stop collar, remove retaining ring A, slide cam B off sleeve C, rotate the cam to the desired position, slide it onto the sleeve again, and replace the retaining ring.

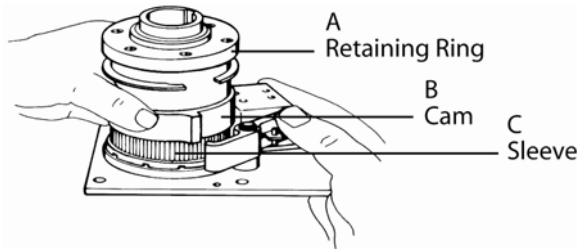

Note: While adjusting the stop collar on split cam units, the coupling sleeve must be held secure so that it does not move.

5.2 Stop Collar Positioning Increments

Series	Size	Collar Design	Adjustment
Super CB	CB-5	Split Cam	1.8°
Super CB	CB-6	Split Cam	1.8°
Super CB	CB-7	Split Cam	1.6°
Super CB	CB-8	Split Cam	1.6°
Super CB	CB-10	Cam	1.5°
Standard CB	CB-2	Cam	2.8°
Standard CB	CB-4	Cam	2.4°
Standard CB	CB-5	Split Cam	1.8°

Series	Size	Collar Design	Adjustment
Standard CB	CB-6	Split Cam	1.8°
Standard CB	CB-7	Split Cam	1.6°
Standard CB	CB-8	Split Cam	1.6°
Standard CB	CB-10	Cam	1.5°
SAC	SAC-2	Cam	2.8°
SAC	SAC-4	Cam	2.4°
SAC	SAC-5	Split Cam	1.8°
SAC	SAC-6	Split Cam	1.8°

6. Performance

	STANDARD		SUPER OR STANDARD				
	CB/SAC-2	CB/SAC-4	CB/SAC-5	CB/SAC-6	CB-7	CB-8	CB-10
Static torque	25 lb-in (2.825 Nm)	120 lb-in (13.56 Nm)	250 lb-in (28.25 Nm)	500 lb-in (56.5 Nm)	1,500 lb-in (169.5 Nm)	2,500 lb-in (282.5 Nm)	5,000 lb-in (565 Nm)
Maximum anti-overrun holding capability	10 lb-in (1.13 Nm)	25 lb-in (2.825 Nm)	45 lb-in (5.085 Nm)	300 lb-in (33.9 Nm)	600 lb-in (67.8 Nm)	600 lb-in (67.8 Nm)	1,200 lb-in (135.6 Nm)
Maximum anti-back holding capability	18 lb-in (2.034 Nm)	80 lb-in (9.04 Nm)	160 lb-in (18.08 Nm)	300 lb-in (33.9 Nm)	600 lb-in (67.8 Nm)	600 lb-in (67.8 Nm)	1,200 lb-in (135.6 Nm)
Inertia, rotating parts	.0207 lb-in ²	.0636 lb-in ²	.1950 lb-in ²	1.718 lb-in ²	6.75 lb-in ²	12.84 lb-in ²	48.0 lb-in ²
Maximum radial bearing load at maximum speed	7.5 lbs.	14 lbs.	32 lbs.	63 lbs.	300 lbs.	300 lbs.	500 lbs.
Maximum operating speed	1,800 RPM	1,200 RPM	750 RPM	500 RPM	400 RPM	300 RPM	200 RPM
Response time, voltage on at full speed	20 MS	24 MS	27 MS	45 MS	50 MS	50 MS	70 MS
Weight	1 lb.	2 lbs.	3 lbs.	7 lbs.	12 lbs.	15 lbs.	27 lbs.

Sales and Service

We are committed to quality customer service. In order to serve in the most effective way, please contact your local sales representative for assistance. If you are unaware of your local sales representative, please contact us.

North America

Thomson Customer Support North America

Phone: 1-540-633-3400

Fax: 1-540-639-4162

www.thomsonlinear.com

